

320566 ✓ ACTIVE



PIDG

TE Internal #: 320566

Knife Disconnects, Tin, Wire Insulation Support, 16 – 14 AWG Wire Size, 1.04 – 2.62 mm<sup>2</sup> Wire Size, 2.05 – 5.18 kcmil Wire Size, Loose Piece, PIDG

[View on TE.com >](#)

Terminals & Splices > Knife Disconnects > PIDG Knife Disconnect Splices

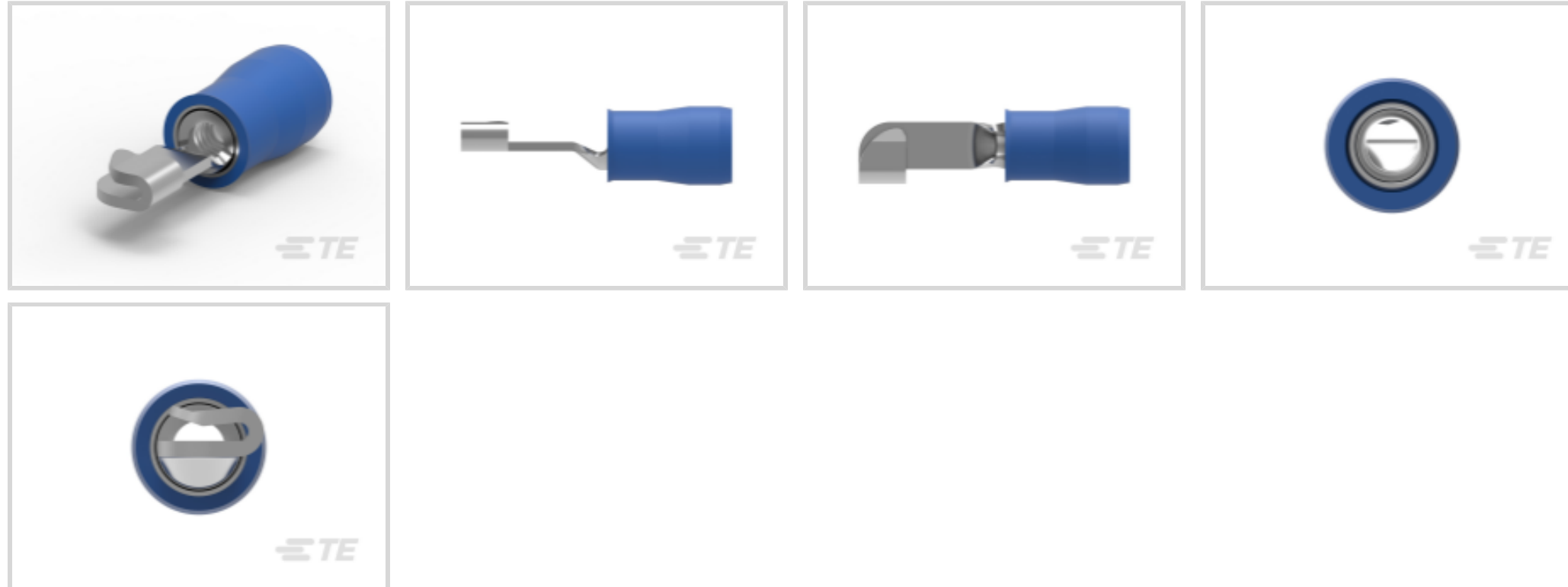

Body Plating Material: Tin

Wire Insulation Support: With

Accepts Wire Insulation Diameter (Max): 3.81 mm [ .15 in ]

Wire Size: 1.04 – 2.62 mm<sup>2</sup>

[All PIDG Knife Disconnect Splices \(9\)](#)

Features

Product Type Features

Sealable	No
----------	----

Body Features

Insulation Sleeve Material	Nylon
Body Plating Material	Tin

Mechanical Attachment

Wire Insulation Support	With
-------------------------	------

Dimensions

Accepts Wire Insulation Diameter (Max)	3.81 mm[.15 in]
Wire Size	2.05 – 5.18 kcmil

Usage Conditions

Insulation Option	Partially Insulated
Operating Temperature Range	105 °C[221 °F]

Packaging Features

Packaging Method	Loose Piece
------------------	-------------

### Other

Barrel Color	Blue
--------------	------

## Product Compliance

[For compliance documentation, visit the product page on TE.com>](#)

EU RoHS Directive 2011/65/EU	Compliant
EU ELV Directive 2000/53/EC	Compliant
China RoHS 2 Directive MIIT Order No 32, 2016	No Restricted Materials Above Threshold
EU REACH Regulation (EC) No. 1907/2006	Current ECHA Candidate List: JUNE 2022 (224) Candidate List Declared Against: JUNE 2022 (224) Does not contain REACH SVHC
Halogen Content	Low Halogen - Br, Cl, F, I < 900 ppm per homogenous material. Also BFR/CFR/PVC Free
Solder Process Capability	Not applicable for solder process capability

### Product Compliance Disclaimer

This information is provided based on reasonable inquiry of our suppliers and represents our current actual knowledge based on the information they provided. This information is subject to change. The part numbers that TE has identified as EU RoHS compliant have a maximum concentration of 0.1% by weight in homogenous materials for lead, hexavalent chromium, mercury, PBB, PBDE, DBP, BBP, DEHP, DIBP, and 0.01% for cadmium, or qualify for an exemption to these limits as defined in the Annexes of Directive 2011/65/EU (RoHS2). Finished electrical and electronic equipment products will be CE marked as required by Directive 2011/65/EU. Components may not be CE marked. Additionally, the part numbers that TE has identified as EU ELV compliant have a maximum concentration of 0.1% by weight in homogenous materials for lead, hexavalent chromium, and mercury, and 0.01% for cadmium, or qualify for an exemption to these limits as defined in the Annexes of Directive 2000/53/EC (ELV). Regarding the REACH Regulation, the information TE provides on SVHC in articles for this part number is based on the latest European Chemicals Agency (ECHA) 'Guidance on requirements for substances in articles' posted at this URL: <https://echa.europa.eu/guidance-documents/guidance-on-reach>

## Compatible Parts

 <p>TE Part # 59824-1 TETRA-CRIMP PIDG PG FASTON 22-10 ASSY</p>	 <p>TE Part # 58433-3 PRO CR ASSY, RBY IS9252</p>	 <p>TE Part # 59250 T-HEAD PIDG 26-14 ASSY</p>	 <p>TE Part # 47387 DAHT PG PIDG 20-14 ASSY</p> <p>REPRESENTATION ONLY</p>
--	--	---	---

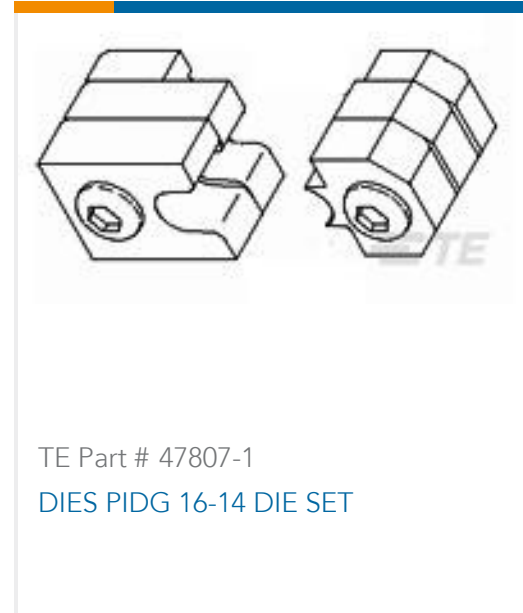

## Also in the Series | PIDG

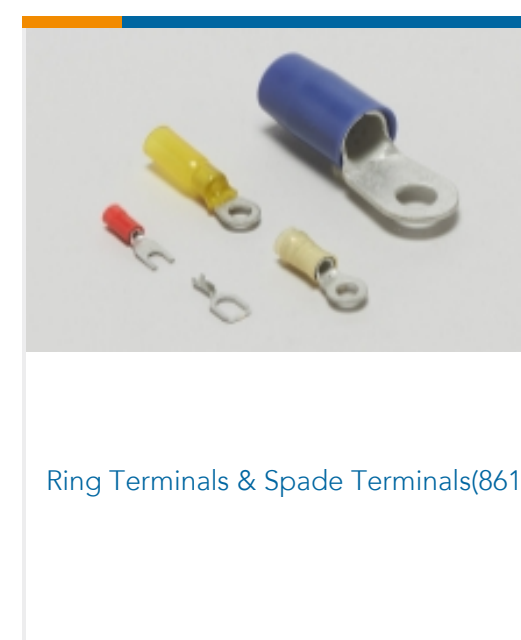
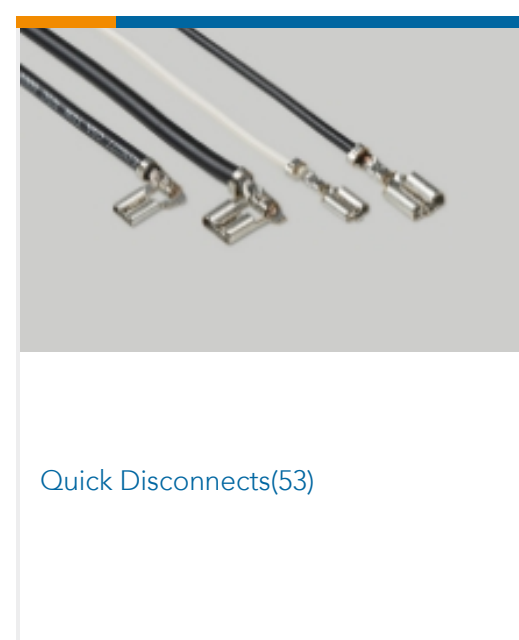
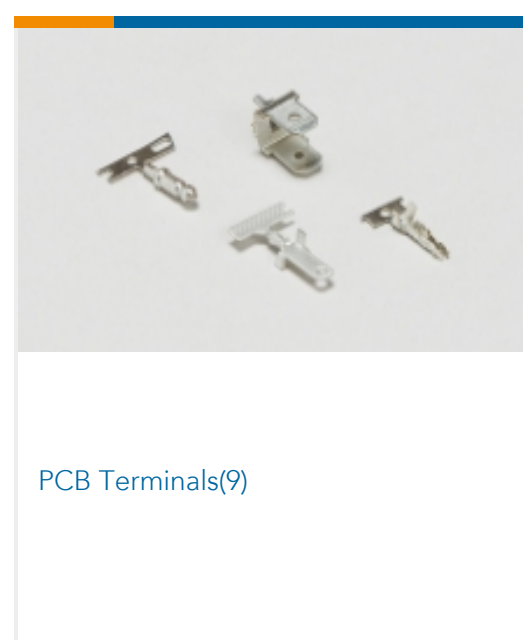
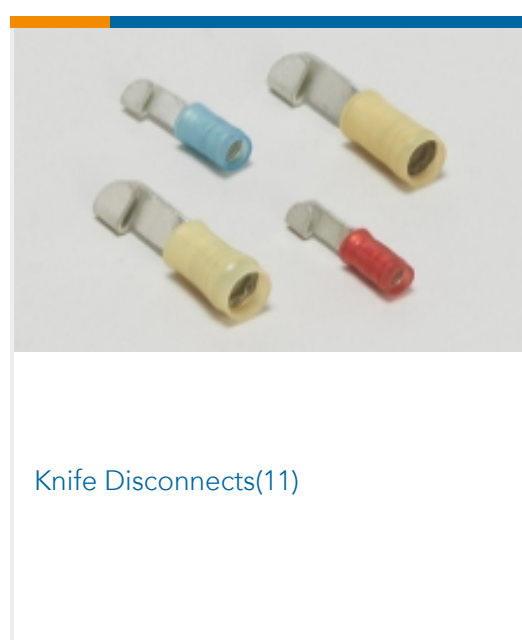
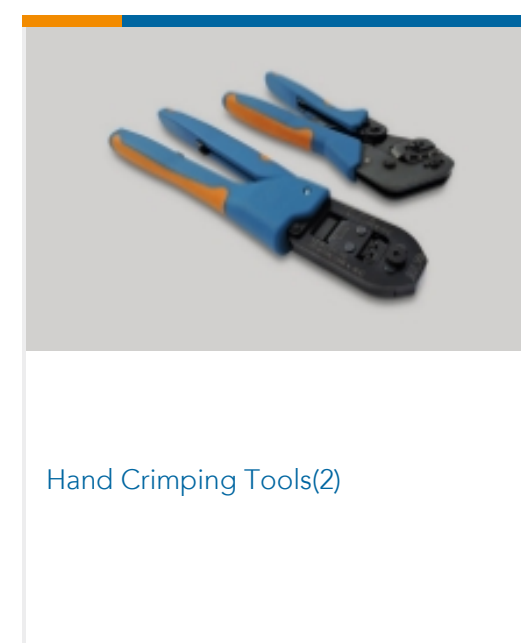
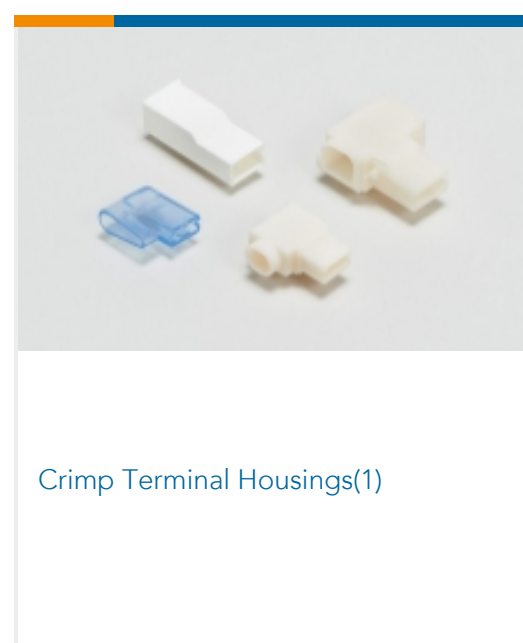
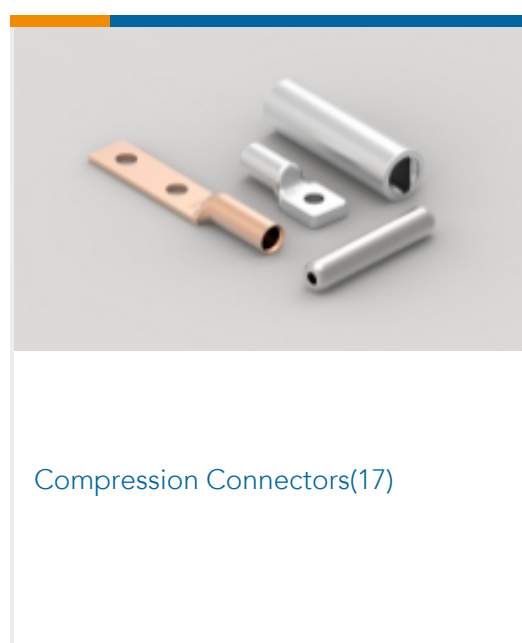

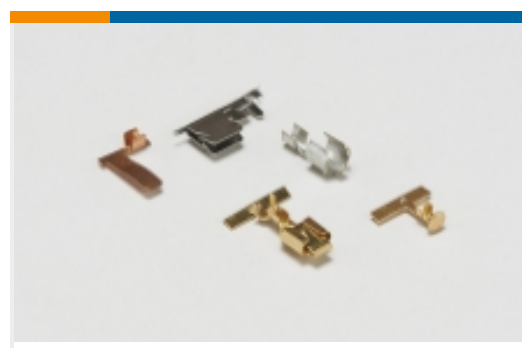

Special Purpose Terminals(1)



Splices(48)

## Documents

### Product Drawings

[KNIFE DISCONNECT,N PIDG 16-14](#)

English

### CAD Files

[3D PDF](#)

3D

Customer View Model

[ENG\\_CVM\\_CVM\\_320566\\_G.2d\\_dxf.zip](#)

English

Customer View Model

[ENG\\_CVM\\_CVM\\_320566\\_G.3d\\_igs.zip](#)

English

Customer View Model

[ENG\\_CVM\\_CVM\\_320566\\_G.3d\\_stp.zip](#)

English

By downloading the CAD file I accept and agree to the [Terms and Conditions](#) of use.

### Product Specifications

[Application Specification](#)

English

### Instruction Sheets

[Instruction Sheet \(U.S.\)](#)

English

### Agency Approvals

[Agency Approval Document](#)

English